

Dell Interactive Projector S560P/ S560T User's Guide



Notes, Cautions, and Warnings



NOTE: A NOTE indicates important information that helps you make better use of your projector



CAUTION: A CAUTION indicates potential damage to hardware or loss of data if instructions are not followed.



WARNING: A WARNING indicates a potential for property damage, personal injury, or death.

**Information in this document is subject to change without notice.
© 2016 Dell Inc. All rights reserved.**

Reproduction of these materials in any manner whatsoever without the written permission of Dell Inc. is strictly forbidden.

Trademarks used in this text: Dell and the DELL logo are trademarks of Dell Inc.; DLP and DLP logo are trademarks of TEXAS INSTRUMENTS INCORPORATED; Microsoft and Windows are either trademarks or registered trademarks of Microsoft Corporation in the United States and/or other countries.

Other trademarks and trade names may be used in this document to refer to either the entities claiming the marks and names or their products. Dell Inc. disclaims any proprietary interest in trademarks and trade names other than its own.

Model: Dell Projector S560P/S560T

June 2016 Rev. A00

Contents

1	About Your Dell Projector	5
	Projector Box Contents	5
	Projector Top and Bottom View	7
	Projector Connections	8
	Adjusting Image Size	10
	Remote Control	12
2	Using Interactive Pen (Only for S560P)	16
	System Requirements.	16
	About Your Interactive Pen	17
	Replacing the Interactive Pen Tips	18
	Replacing the Interactive Pen Batteries	19
	Using Interactive Pen with S560P.	20
	Touch Area Setting.	21
	Pen Calibration	23
3	Using Interactive Touch (Only for S560T)	24
	System Requirements.	24
	Setting Up Interactive Touch	25
	Using Interactive Touch with S560T	25
	Touch Area Setting.	27
	Interactive Touch Calibration.	29
	Using S560T and Dry Erase Whiteboard.	30
4	Connecting Wireless Display Adapter	31
	Installing Wireless Display Adapter	31
	Setting up the Wireless Display Adapter.	32
5	Troubleshooting	33
	Troubleshooting Tips	33
	Guiding Signals	37
6	Maintenance	38
	Changing the Lamp	38
	Replacing Remote Control Batteries	40

7	Specifications	41
8	Additional Information	45
9	Contacting Dell	46

1

About Your Dell Projector

Your projector comes with all the items shown below. Ensure that you have all the items, and contact Dell if anything is missing.

Projector Box Contents

Package Contents

Power cable

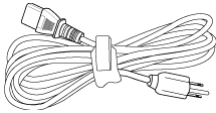

5 m VGA cable (VGA to VGA)

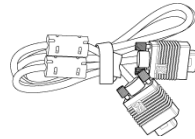

Remote control



AAA Batteries (2 for S560T; 6 for S560P)



CD, User's Guide, and Documentation 5 m Mini cable (USB-A to Mini B)

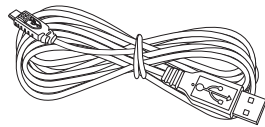
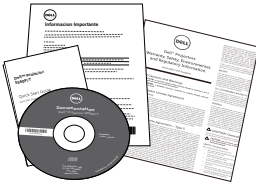

Package Contents (S560P only)

Interactive pen (2 pcs)/
Pen tip cap (4 pcs)

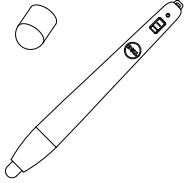

Wrist strap (2pcs)



Package Contents (S560T only)

Touch Unit

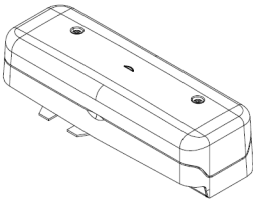

2 m DC to DC power cable (for
Touch unit)

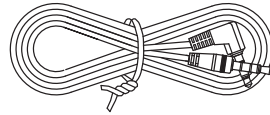

Passive Pen (2 pcs)/ Pen Nib(2 pcs)

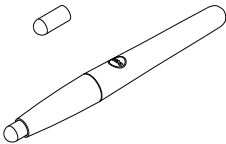

Touch unit Base Plate kit

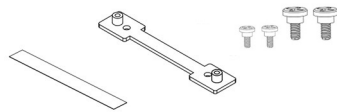

Projector Top and Bottom View

Top View

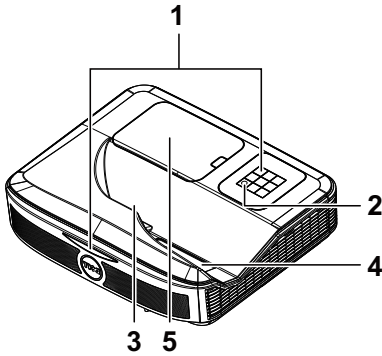

Bottom View

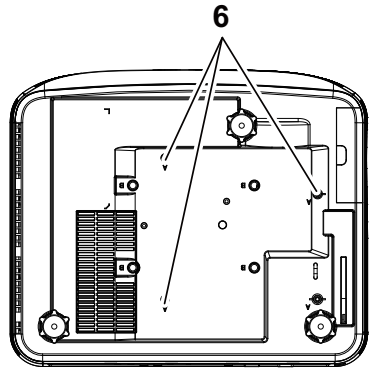

-
- | | |
|---|-------------------------------|
| 1 | Infrared (IR) receivers |
| 2 | Power button |
| 3 | Camera |
| 4 | Lens |
| 5 | Lamp cover |
| 6 | Mounting holes for wall mount |
- A : Dell S560 wall mount
B : Universal wall mount
-



NOTE: Wall mount screw hole M4 X 4. Recommended torque < 15 kgf-cm.

Projector Connections

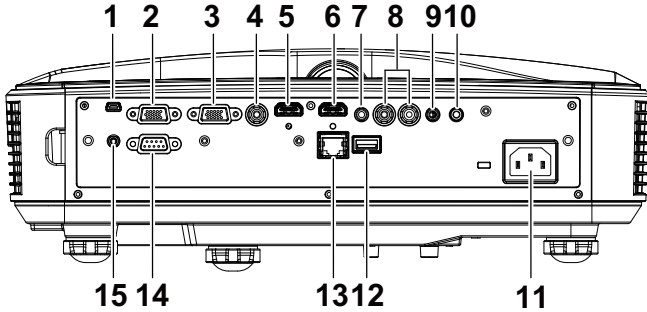

1	Mini USB (Mini Type B)	9	Microphone connector
2	VGA Out connector (monitor loop through)	10	Audio Output connector
3	VGA In connector	11	Power cord connector
4	Composite Video connector	12	USB A connector
5	HDMI 2 connector	13	RJ 45 connector
6	HDMI 1 connector	14	RS232 connector
7	Audio Input connector	15	Touch Unit power
8	Audio RCA connector		

CAUTION: Before you begin any of the procedures in this section, follow the Safety Instructions as described on page 9.

CAUTION: Safety Instructions

- 1 Do not use the projector near appliances that generate a lot of heat.
- 2 Do not use the projector in areas where there is an excessive amount of dust. The dust may cause the system to fail and the projector will automatically shutdown.
- 3 Ensure that the projector is mounted in a well-ventilated area.
- 4 Do not block the ventilation slots and openings on the projector.
- 5 Ensure the projector operates between ambient temperatures (5 °C to 40 °C).
- 6 Do not try to touch the ventilation outlet as it can become very hot after the projector has been turned on or immediately after it is turned off.
- 7 Do not look into the lens while the projector is on as it may cause injury to your eyes.
- 8 Do not place any objects near or in front of the projector or cover its lens while the projector is on as the heat may cause the object to melt or burn.
- 9 Do not use alcohol to wipe the lens.



NOTE:

- Do not attempt to wall mount the projector by yourself. It should be installed by a qualified technician.
- Recommended Projector Wall Mount Kit. For more information, see the Dell Support website at [dell.com/support](https://www.dell.com/support).
- For more information, see the Safety Information that shipped with your projector.
- The S560P/ S560T projector can only be used indoors.

Adjusting Image Size

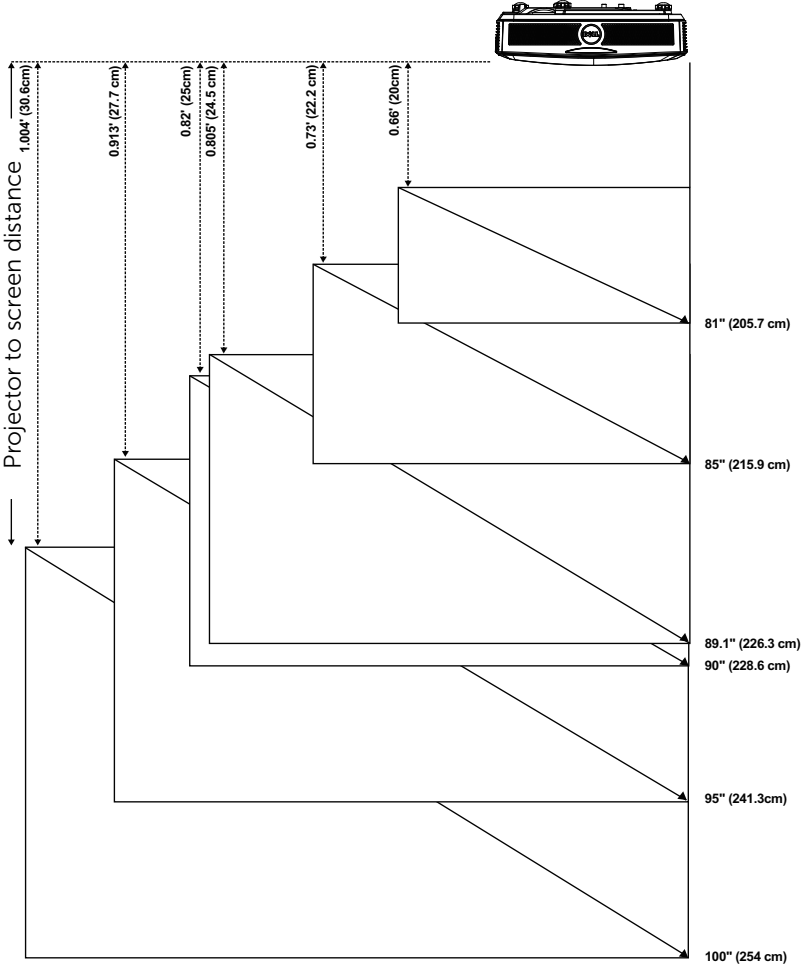



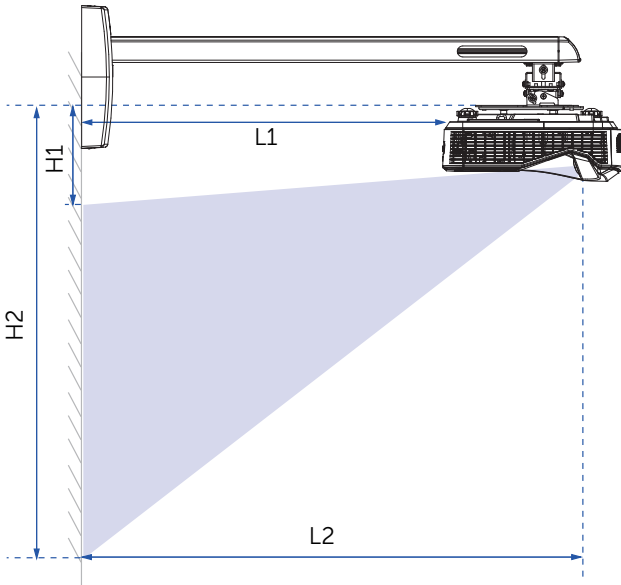

Adjusting Image Shape



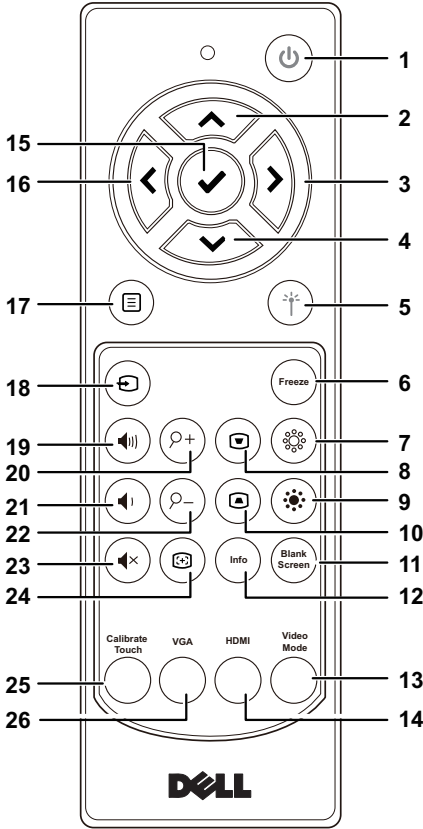





Screen Size						H1	H2	L1		L2			
Diagonal		Width		Height				wide		wide			
inch	mm	inch	mm	inch	mm	inch	mm	inch	mm	inch	mm		
81	2057	71	1793	40	1009	6	145	45	1153	8	200	18	452
85	2159	74	1882	42	1059	6	154	48	1212	9	222	19	474
89.1	2263	78	1972	44	1110	6	163	50	1273	10	245	20	497
90	2286	78	1992	44	1121	7	165	51	1286	10	250	20	502
95	2413	83	2103	47	1183	7	177	54	1360	11	278	21	530
100	2540	87	2214	49	1245	7	188	56	1434	12	306	22	558









Remote Control



1	Power 	Turns the projector on or off.
2	Up 	Press to navigate through the On-Screen Display (OSD) Menu items.
3	Right 	Press to navigate through the On-Screen Display (OSD) Menu items.
4	Down 	Press to navigate through the On-Screen Display (OSD) Menu items.

5	Laser 	Point the remote control at the screen, press and hold the laser button to activate the laser light. ⚠ WARNING: Do not look at the laser point when it is active. Avoid directing the laser light on your eyes.
6	Freeze	Press to pause the screen image, then press "Freeze" again to unfreeze the image.
7	Brightness + 	Press to increase the brightness.
8	Keystone adjustment + 	Press to adjust image distortion caused by tilting the projector (+/-40 degrees).
9	Brightness - 	Press to decrease the brightness.
10	Keystone adjustment - 	Press to adjust image distortion caused by tilting the projector (+/-40 degrees).
11	Blank screen	Press to toggle among displaying blank white and black screens and return to presentation.
12	Info	Press to display the projector information.
13	Video mode	The projector has preset configurations that are optimized for displaying data (presentation slides) or video (movies, games, etc.). Press the Video Mode button to toggle between Presentation mode , Bright mode , Movie mode , sRGB , or Custom mode . Pressing the Video Mode button once will show the current display mode. Pressing the Video Mode button again will switch between modes.
14	HDMI	Press to choose HDMI source.
15	Enter 	Press to confirm the selection.
16	Left 	Press to navigate through the On-Screen Display (OSD) Menu items.
17	Menu 	Press to activate the OSD.
18	Source 	Press to switch between VGA, Composite, HDMI-1, and HDMI-2 source.

19	Volume up 	Press to increase the volume.
20	Zoom + 	Press to increase the image.
21	Volume down 	Press to decrease the volume.
22	Zoom - 	Press to decrease the image.
23	Mute 	Press to mute or un-mute the projector speaker.
24	Auto Adjust 	Press to auto adjust the displayed image.
25	Calibrate Touch	Press to calibrate touch to adjust for better accuracy.
		 NOTE: Setup Utility is required.
26	VGA	Press to choose VGA source.

Remote Control Operating Range

Operating range	
Angle	$\pm 30^\circ$
Distance	7 m/22.97 feet

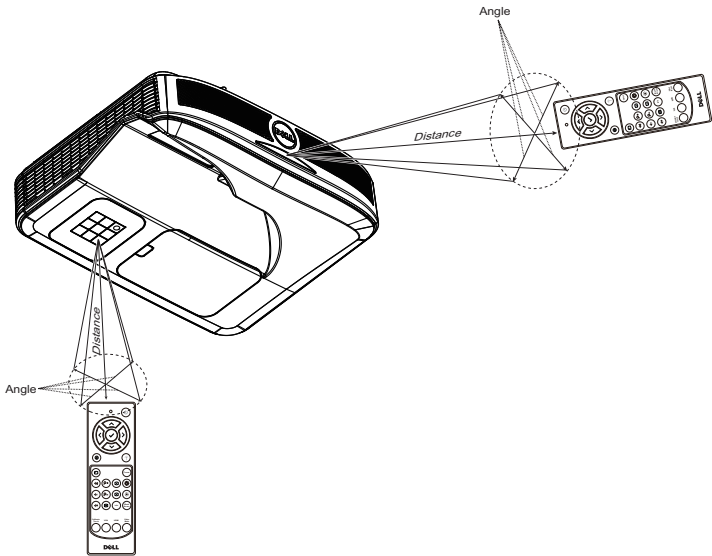

NOTE: Actual operating range may slightly differ from the diagram. Weak batteries will also prevent the remote control from properly operating the projector.

2

Using Interactive Pen (Only for S560P)

The S560P projector projects the connected computer's desktop image onto the whiteboard and it acts as input device to the computer. You can navigate, select, and interact with your computer programs from the whiteboard.

The S560P is a pen-based interactive projector. Download and install Dell S560x Interactive Utility for first-time setup and interactivity calibration.

System Requirements



NOTE: Your computer must have the following minimum system requirements:

Operating System	Number of touch points supported	Installation of S560x Interactive Utility* ¹	
		For first-time setup	For subsequent use
Windows 7/8/10	10 touch points	Supported* ³	Not required
MAC OS X (10.7~10.11)	1 touch point* ⁴	Supported	Required, please install the setup utility on all Mac OS computers, to use them with the S560P
ChromeBook	10 touch points	Not supported, please use a Windows OS or Mac OS computer to complete first-time setup for the S560P	Not required

*1 : Get S560x Interactive Utility from provided CD or download it from Dell Support

*2 : S560P requires first-time calibration, ensure you calibrate the interactive pen(s) before use

*3 : .NET Framework 4.0 installation is required

*4 : Mac OS support 1 touch point only



NOTE: For better accuracy, you should set to "Projector Only" display mode before calibration. More details about touch function and calibration in different display modes, please go to "S560T Touch setup Guide" Troubleshooting Q2.

About Your Interactive Pen

The interactive pen allows user to interact with projected content in the same fashion as a mouse input.

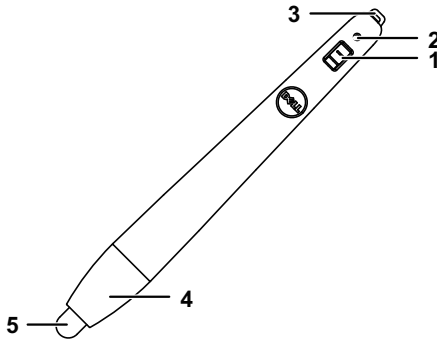

1	Power switch
2	Power indicator As you turn on the pen, the power indicator flashes a few seconds and goes off. Green: Normal operation Red: Battery is low No light: Battery is empty
3	Wrist strap holder
4	Battery compartment access. Turn to open and replace batteries.
5	Pen tip

Replacing the Interactive Pen Tips



NOTE: If the pen tip becomes damaged, or no longer works well, you should replace them.

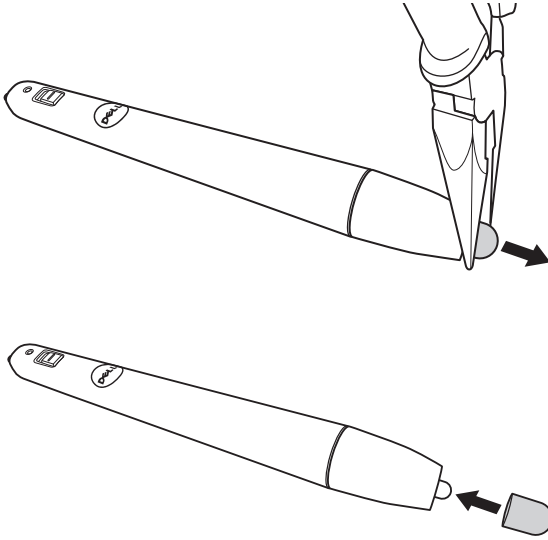

Replacing the Interactive Pen Batteries



NOTE: If the battery is low, the LED indicator starts flashing red as you turn on the pen. You should replace with two new AAA batteries.

1 You can access the battery compartment by turning open the pen head.

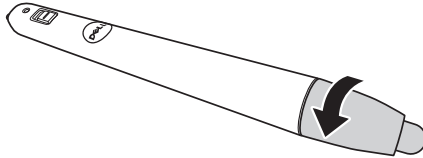

2 Insert the batteries and align their polarity correctly according to the marking on the pen head.

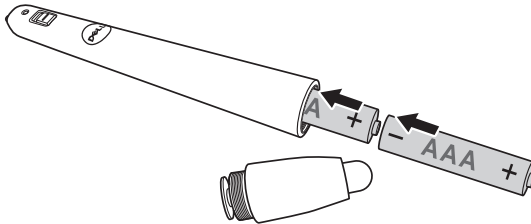

NOTE: Avoid mixing different types of batteries or using new and old batteries together.

3 Place the pen head back, turn until the battery compartment access is fully closed.

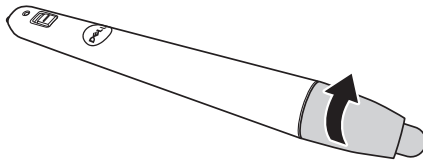

Using Interactive Pen with S560P

Step 1: Connect the computer with the projector using HDMI/ VGA cable to display image. Connect the USB cable for using in interactive mode. If using Mac OS, run the S560x Interactive utility to setup the pen.

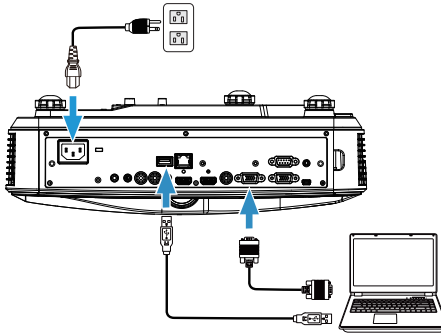

Step 2. Run Dell S560x Interactive Utility, users can select default Interactive Mode () for multi-point touch. Switch to Active Pen Mode for S560P.

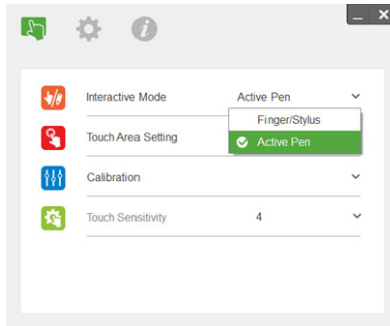

Only single-point touch supported for Mac OSX



NOTE: For Mac OS computer, Dell S560x Interactive Utility must be executed.

Touch Area Setting

Switch to display mode "Projector only".

1 Select Auto Touch Area Setting:

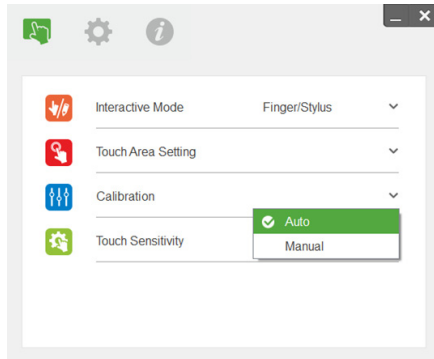

NOTE:

- Quit all software applications
- Reduce ambient light
- Do not obstruct or shake lens during Touch Area Setting
- Check if projection image is clear. If not, adjust focus to sharpen the image
- If fail message pops up, switch to Manual Touch Area Setting.

2 Select Manual Touch Area Setting:

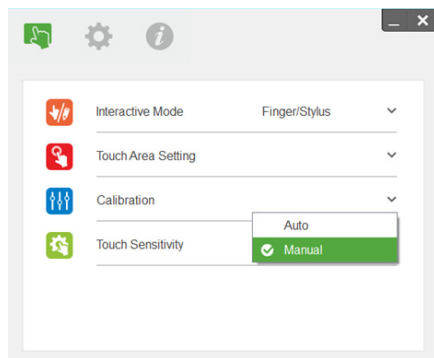

- 2-1** After the camera captures the projection image, a Touch Area window will pop up. If the captured image is not clear enough, please re-select "Ambient light mode selection" from "Auto" to "Bright" or "Dim" according to actual ambient light condition.

Remark: Captured image shows the actual camera view, which is reversed from projection image. For example: P1 is lower right corner, P2 is lower left corner and so on.

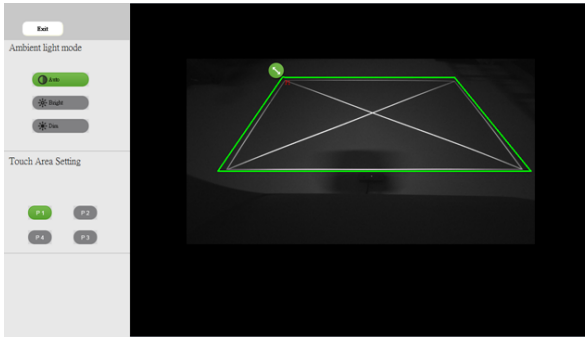

2-2 Touch Area Boundary Fine-tuning

Step 1: Click on P1, use mouse to drag P1 to upper left corner. Align adjustable green zone with projected white frame.

Step 2: Adjust P2 to P4 accordingly; adjustable green zone should completely overlaps the projected white frame.

Step 3: Finally, check again if the green frame completely overlaps the projected white frame. If not, fineadjust again.

- 2-3** When the Touch Area is correctly located then click exit button.

Pen Calibration

- 1 Switch to display mode "Projector only".
- 2 Perform touch calibration on S560P using the S560x interactive utility (Win, Mac).
- 3 Select auto-calibration while running the S560X interactive utility.

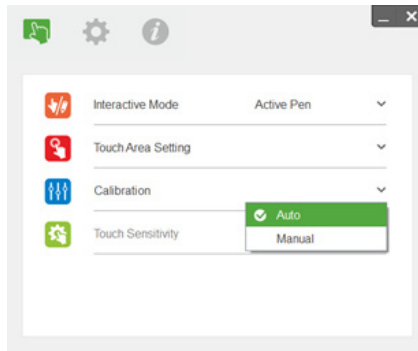

NOTE: If the fail message pops up, follow below steps to troubleshoot and do Auto Calibration again.

- Close all software applications
- Reduce ambient light
- Do not obstruct or shake lens during calibration
- Check if projected image is clear, if not, adjust focus to sharpen the image

If auto-calibration fails, setup using 'manual calibration'.

- 4 Select Manual Calibration, and follow the steps for calibration. Manual Calibration is suggested to get a better accuracy.

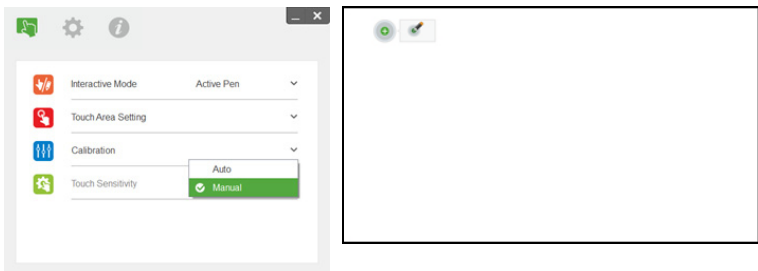

3

Using Interactive Touch (Only for S560T)

The S560T projector projects the connected computer's desktop image onto the whiteboard and it acts as input device to the computer. You can navigate, select, and interact with your computer programs from the whiteboard.

The S560T projector is a 10-pt multi-touch interactive projector. To setup the interactive function, install the touch unit as described in the 'Touch setup guide'. Also, use the Dell S560x Interactive utility for first-time setup and calibration which can be found in CD & download from Dell Support.

System Requirements



NOTE: Your computer must have the following minimum system requirements::

Operating System	Number of touch points supported	Installation of S560x Interactive Utility ^{*1}	
		For first-time setup	For subsequent use
Windows 7/8/10	10 touch points	Supported ^{*3}	Not required
MAC OS X (10.7~10.11)	1 touch point ^{*4}	Supported	Required, please install the setup utility on all Mac OS computers, to use them with the S560T
ChromeBook	10 touch points	Not supported, please use a Windows OS or Mac OS computer to complete first-time setup for the S560T	Not required

*1 : Get S560x Interactive Utility from provided CD or download it from Dell Support

*2 : S560T requires first-time alignment and calibration, ensure you complete setup process before use

*3 : NET Framework 4.0 installation is required

*4 : Mac OS support 1 touch point only



NOTE: For better accuracy, you should set to "Projector Only" display mode before calibration. More details about touch function and calibration in different display modes, please go to "S560T Touch setup Guide" Troubleshooting Q2.

Setting Up Interactive Touch

To setup the interactive function, install the touch unit as described in the 'Touch setup guide'.

Using Interactive Touch with S560T

Step 1: Connect the computer with the projector using HDMI/ VGA cable to display image. Connect the USB cable for using in interactive mode. If using Mac OS, run the S560x Interactive utility to setup the touch functionality.

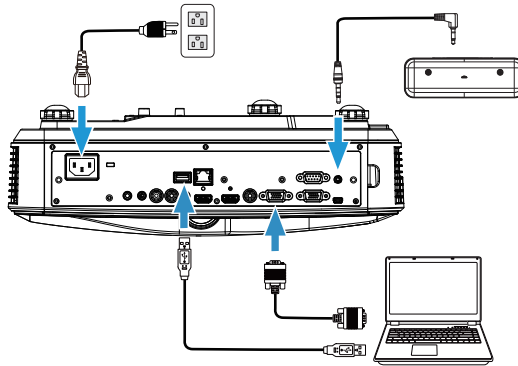

Step 2:

Running Dell S560x Interactive Utility, users can select default Interactive Mode () for multi-point touch. Switch to Finger/Stylus Mode for S560T with Touch Unit interactive touch.

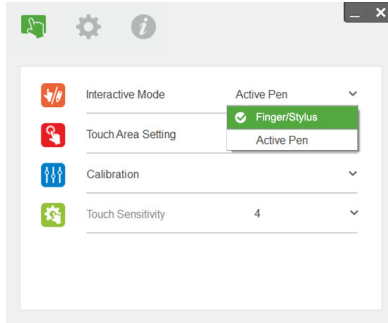

Only single-point touch is available for Mac OS X system.



NOTE: For Mac OS computer, Dell S560x Interactive Utility must be executed.

Touch Area Setting

Switch to display mode "Projector only".

1 Select Auto Touch Area Setting:

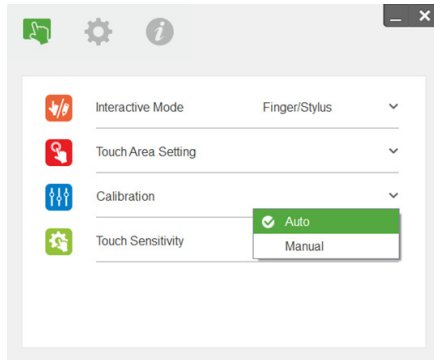

NOTE:

- Quit all software applications
- Reduce ambient light
- Do not obstruct or shake lens during Touch Area Setting
- Check if projection image is clear. If not, adjust focus to sharpen the image
- If fail message pops up, switch to Manual Touch Area Setting.

2 Select Manual Touch Area Setting:

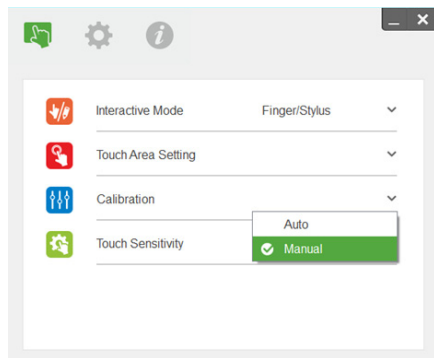

- 2-1** After the camera captures the projection image, a Touch Area window will pop up. If the captured image is not clear enough, please re-select "Ambient light mode selection" from "Auto" to "Bright" or "Dim" according to actual ambient light condition.

Remark: Captured image shows the actual camera view, which is reversed from projection image. For example: P1 is lower right corner, P2 is lower left corner and so on.

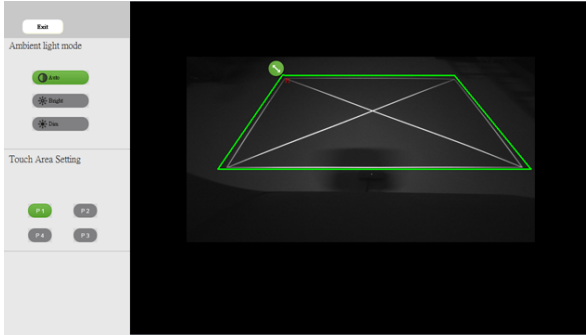

2-2 Touch Area Boundary Fine-tuning

Step 1: Click on P1, use mouse to drag P1 to upper left corner. Align adjustable green zone with projected white frame.

Step 2: Adjust P2 to P4 accordingly; adjustable green zone should completely overlaps the projected white frame.

Step 3: Finally, check again if the green frame completely overlaps the projected white frame. If not, fineadjust again.

- 2-3** When the Touch Area is correctly located then click exit button.

Interactive Touch Calibration

- 1 Switch to display mode "Projector only".
- 2 Perform touch calibration on S560P using the S560x interactive utility (Win, Mac).
- 3 Select auto-calibration while running the S560X interactive utility.

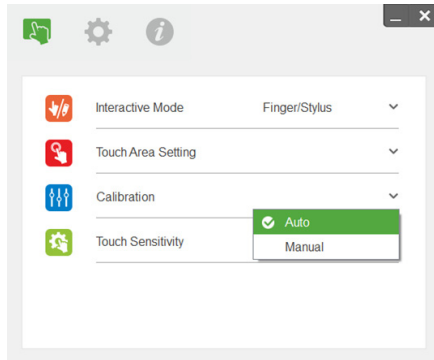

NOTE: If the fail message pops up, follow below steps to troubleshoot and do Auto Calibration again.

- Close all software application
- Reduce ambient light
- Do not obstruct or shake lens during calibration
- Check if projection image is clear, if not, adjust focus to sharpen the image

If auto-calibration fails, setup using 'manual calibration'.

- 4 Select Manual Calibration, and follow the steps for calibration. Manual Calibration is suggested to get a better accuracy.

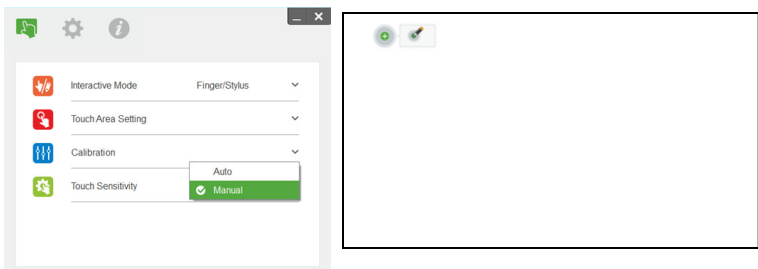

Using S560T and Dry Erase Whiteboard

To use the dry-erase marker on whiteboard without affecting the touch operation, use the 'freeze' key or the 'blank screen' key on the remote.

- 1 Freeze: Use the freeze key to pause the image on the screen and suspend touch functionality. Press the freeze key again to resume touch operation.

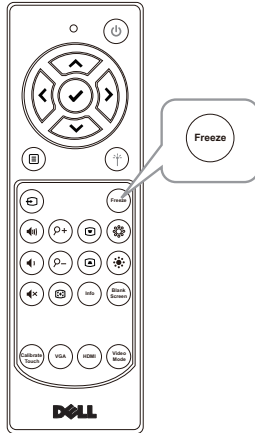

- 2 Blank screen: Use Blank screen key to display a blank screen on the projector. Press the key to toggle between white background/ black background and to resume normal operation. During 'blank screen' mode, touch operation is suspended.

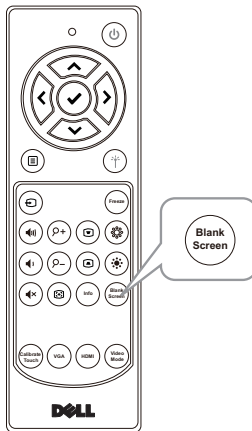

4

Connecting Wireless Display Adapter

Installing Wireless Display Adapter

Your projector has HDMI and USB power port for wireless display adapter. The wireless display adapter is not shipped with your S560P/S560T.

The installation steps are as below:

- 1 Make sure projector is already powered off.
- 2 Attach the power USB cable to the wireless display adapter and then attach the wireless display adapter.

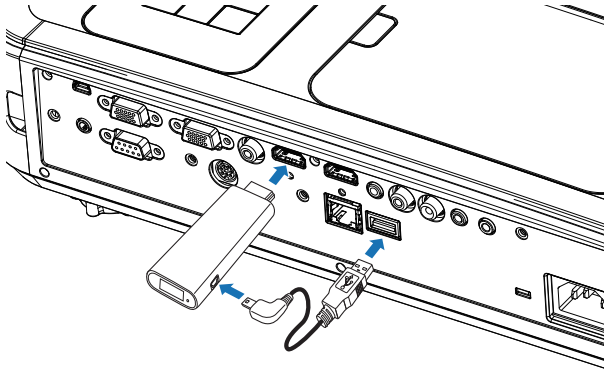

NOTE: The power USB cable is shipped with wireless display adapter and not shipped with your projector.

Setting up the Wireless Display Adapter

1 Power on the projector.

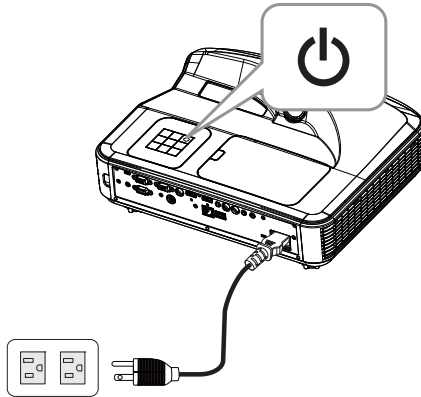

2 Switch to "Wireless Display" source.

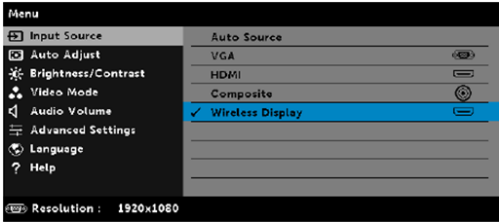

3 Refer to your Wireless Display Adapter setup instructions to proceed with wireless projection.

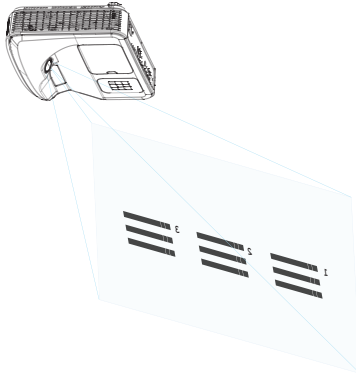

5

Troubleshooting

Troubleshooting Tips



If you experience problems with your projector, see the following troubleshooting tips. If the problem persists, contact Dell: www.dell.com/contactDell.



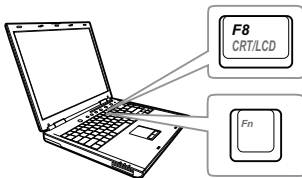

Problem

No image appears on the screen



Possible Solution

- Ensure that you have chosen the correct input source on the INPUT SOURCE menu.
 - Ensure the external graphics port is enabled. If you are using a Dell laptop computer, press   (Fn+F8). For other computers, see your respective documentation. If images are not displayed properly, please upgrade the video driver of your computer. For Dell computers, see www.dell.com/support.
 - Ensure that all the cables are securely connected. See "Adjusting Image Size" on page 10.
 - Ensure that the pins of the connectors are not bent or broken.
 - Ensure that the lamp is securely installed (see "Changing the Lamp" on page 38).
 - Use the Test Pattern in the Projector Settings of the Advanced Settings menu. Ensure that the colors of the test pattern are correct.
-

Problem (continued)	Possible Solution (continued)
Partial, scrolling, or incorrectly displayed image	<ol style="list-style-type: none"> 1 Press the Auto Adjust button on the remote control. 2 If you are using a Dell laptop computer, set the resolution of the computer to 1080p (1920 x 1080): <ol style="list-style-type: none"> a Right-click the unused portion of your Microsoft® Windows® desktop, click Properties, and then select Settings tab. b Verify that the setting is 1920 x 1080 pixels for the external monitor port. c Press   (Fn+F8). <p>If you experience difficulty in changing resolutions, or if your monitor freezes, restart all the equipment and the projector.</p> <p>If you are not using a Dell laptop computer, see your documentation. If images are not displayed properly, please upgrade the video driver of your computer. For a Dell computer, see www.dell.com/support.</p>
The screen does not display your presentation	If you are using a portable computer, press   (Fn+F8).
Image is unstable or flickering	Adjust the tracking in the OSD Display Settings of the Advanced Settings menu (in PC Mode only).
Image has vertical flickering bar	Adjust the frequency in the OSD Display Settings of the Advanced Settings menu (in PC Mode only).

Problem (continued)	Possible Solution (continued)
Image color is incorrect	<ul style="list-style-type: none"> • If the display receives the wrong signal output from the graphics card, please set the signal type to RGB in the OSD Image Settings of the Advanced Settings tab. • Use Test Pattern in the Projector Settings of the Advanced Settings menu. Ensure that the colors of the test pattern are correct.
Image is out of focus	<ol style="list-style-type: none"> 1 Ensure that the projection screen is within the required distance from the projector (1.46 ft [44.6cm] ~1.83ft [55.8]).
The image is stretched when displaying a 16:9 DVD	<p>The projector automatically detects the input signal format. It will maintain the aspect ratio of the projected image according to the input signal format with an Original setting.</p> <p>If the image is still stretched, adjust the aspect ratio in the Display Settings of the Advanced Settings menu in the OSD.</p>
Image is reversed	<p>Select Projector Settings of the Advanced Settings from the OSD and adjust the projector mode.</p>
Lamp is burned out or makes a popping sound	<p>When the lamp reaches its end of life, it may burn out and may make a loud popping sound. If this occurs, the projector does not turn back on. To replace the lamp, see "Changing the Lamp" on page 38.</p>
LAMP light is solid amber	<p>If the LAMP light is solid amber, replace the lamp.</p>

Problem (continued)	Possible Solution (continued)
LAMP light is blinking amber	<p>If the LAMP light is blinking amber, the lamp module connection may be disrupted. Please check the lamp module and ensure that it is properly installed.</p> <p>If the LAMP lights and the Power light is blinking amber, the lamp driver has failed and the projector will automatically shut down.</p> <p>If the LAMP and TEMP lights are blinking amber and the Power light is solid blue, the color wheel has failed and the projector will automatically shut down.</p> <p>To clear the protection mode, press and hold the POWER button for 10 seconds.</p>
TEMP light is solid amber	<p>The projector has overheated. The display automatically shuts down. Turn the display on again after the projector cools down. If the problem persists, contact Dell: www.dell.com/contactDell.</p>
TEMP light is blinking amber	<p>If the projector fan fails, the projector will automatically shut down. Try to clear the projector mode by pressing and holding the Power button for 10 seconds. Please wait for about 5 minutes and try to power up again. If the problem persists, contact Dell: www.dell.com/contactDell.</p>
The remote control is not operating smoothly or works only within a limited range	<p>The battery may be low. If so, replace with two new AAA batteries.</p>

Guiding Signals

Projector Status	Description	Control Buttons	Indicator	
		Power	TEMP (Amber)	LAMP (Amber)
Standby mode	Projector in Standby mode. Ready to power on.	White Flashing	OFF	OFF
Warming up mode	Projector takes some time to warm up and power on.	White	OFF	OFF
Lamp on	Projector in Normal mode, ready to display an image.  Note: The OSD menu is not accessed.	White	OFF	OFF
Cooling mode	Projector is cooling to shutdown.	White	OFF	OFF
Projector overheated	Air vents might be blocked or ambient temperature may be above 40°C. The projector automatically shuts down. Ensure that the air vents are not blocked and that the ambient temperature is within operational range. If the problem persists, contact Dell.	OFF	AMBER	OFF
Fan breakdown	One of the fans has failed. The projector automatically shuts down. If the problem persists, contact Dell.	OFF	AMBER Flashing	OFF
Lamp driver breakdown	The lamp driver has failed. The projector automatically shuts down. Unplug the power cord. After three minutes plug the power cord and turn the display on again. If this problem persists, contact Dell.	AMBER Flashing	OFF	AMBER Flashing
Color Wheel breakdown	Color wheel cannot start. The projector has failed and the projector automatically shuts down. Unplug the power cord. After three minutes plug the power cord and turn the display on again. If this problem persists, contact Dell.	White	AMBER Flashing	AMBER Flashing
Lamp failure	Lamp is defective. Replace the lamp.	OFF	OFF	AMBER
Fault - DC supply (+12V)	Power supply has been interrupted. The projector automatically shuts down. Unplug the power cord. After three minutes plug the power cord and turn the display on again. If this problem persists, contact Dell.	AMBER Flashing	AMBER	AMBER
Lamp module connection failed	Lamp module connection may be disrupted. Check the lamp module and ensure that it is properly installed. If the problem persists, contact Dell.	OFF	OFF	AMBER Flashing

6

Maintenance

Changing the Lamp

CAUTION: Before you begin any of the procedures in this section, follow the Safety Instructions as described on page 9.

Replace the lamp when the message "Lamp is approaching the end of its useful life in the operation. Replacement suggested!" appears on the screen. If this problem persists after replacing the lamp, contact Dell.
www.dell.com/lamps

CAUTION: Use an original lamp to ensure safe and optimal working condition of your projector.

CAUTION: The lamp becomes very hot when in use. Do not attempt to replace the lamp until the projector has been allowed to cool down for at least 30 minutes.

CAUTION: Do not touch the bulb or the lamp glass at any time. Projector lamps are very fragile and may shatter if touched. The shattered glass pieces are sharp and can cause injury.

CAUTION: If the lamp shatters, remove all broken pieces from the projector and dispose or recycle according to state, local, or federal law. For more information see www.dell.com/hg.

- 1 Turn off the projector and disconnect the power cord.
- 2 Let the projector cool for at least 30 minutes.
- 3 Loosen the screw that secures the top cover, and remove the cover.
- 4 Loosen the screw that secures the lamp.
- 5 Pull the lamp up by its metal handle.

NOTE: Dell may require lamps replaced under warranty to be returned to Dell. Otherwise, contact your local waste disposal agency for the address of the nearest deposit site.

- 6 Replace with the new lamp.
- 7 Tighten the screw that secures the lamp.

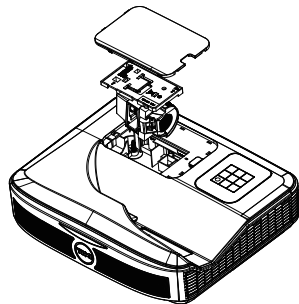

- 8 Replace the top cover and tighten the screw.
- 9 Reset the lamp usage time by selecting "Yes" for **Lamp Reset** in the OSD **Power Settings** of the **Advanced Settings** menu. When a new lamp module has been changed, the projector will automatically detect and reset the lamp hours.



CAUTION: Lamp Disposal (for the US only)

 **LAMP(S) INSIDE THIS PRODUCT CONTAIN MERCURY AND MUST BE RECYCLED OR DISPOSED OF ACCORDING TO LOCAL, STATE, OR FEDERAL LAWS. FOR MORE INFORMATION, GO TO WWW.DELL.COM/HG OR CONTACT THE ELECTRONIC INDUSTRIES ALLIANCE AT WWW.EIAE.ORG. FOR LAMP-SPECIFIC DISPOSAL INFORMATION, CHECK WWW.LAMPRECYCLE.ORG.**

Replacing Remote Control Batteries



NOTE: Remove the batteries from the remote control when not in use.

1 Press the tab to lift the battery compartment cover.

1

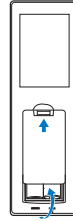

2 Check the polarity (+/-) marking on the batteries.

2

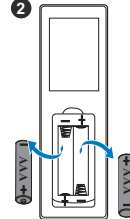

3 Insert the batteries and align their polarity correctly according to the marking in the battery compartment.

3

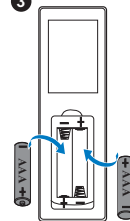

4 Slip the battery cover back.

4

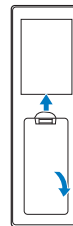

7

Specifications

Light Valve	0.65" 1080p S600 DMD, DarkChip3™
Brightness	3400 ANSI Lumens (Max.)
Contrast Ratio	1800:1 Typical (Full On/Full Off)
Uniformity	80% Typical (Japan Standard - JBMA)
Number of Pixels	1920 x 1080 (1080p)
Aspect Ratio	16:9
Displayable Color	1.07 billion colors
Color Wheel Speed	2 X
	1 X for 3D Display
Projection Lens	Fixed Lens(WA21), F#/2.4
	Throw ratio =UST TR0.25
	Offset ratio: 118.5 ± 5%
Projection Screen Size	81 ~100 inches
	Optimized size: 89.1 inches
Projection Distance	1.46 ~1.83ft (44.6cm ~55.8)
Video Compatibility	Composite Video:
	NTSC: M (3.58 MHz), 4.43 MHz
	PAL: B, D, G, H, I, M, N, 4.43 MHz
	SECAM: B, D, G, K, K1, L, 4.25/4.4 MHz
	Component Video input via VGA: 1080i (50/60 Hz), 720p (50/60 Hz), 576i/p, 480i/p
	HDMI input: 1080p, 720p, 576i/p, 480i/p
Power Supply	Universal AC 90~264 V 50-60 Hz with PFC input

Power Consumption	<p>Normal mode: 320 W \pm 10% @ 110 Vac</p> <p>Eco mode: 270 W \pm 10% @ 110 Vac</p> <p>Standby mode: < 0.5 W</p> <p>Network standby: < 3 W</p> <p> NOTE: By default, the projector is set to enter power saving mode after 20 minutes of inactivity.</p>
Audio	2 speaker x 10 watt RMS
Noise Level	<p>Normal mode: 36 dB(A)</p> <p>Eco mode: 32 dB(A)</p>
Projector Weight	10.36 lbs (4.7kg)
Dimensions (W x H x D)	15.08 x 12.52 x 4.06 inches (383 x 318 x 103 mm)

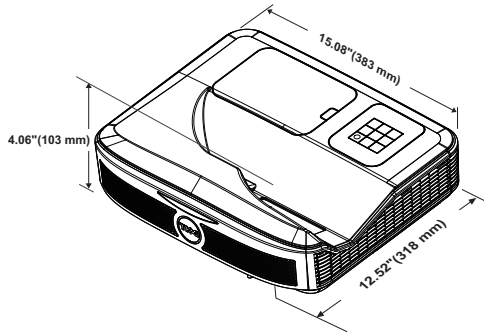

Environmental	<p>Operating temperature: 5 °C - 40 °C (41 °F- 104 °F)</p> <p>Humidity: 80% maximum</p> <p>Storage temperature: 0 °C to 60 °C (32 °F to 140 °F)</p> <p>Humidity: 90% maximum</p> <p>Shipping temperature: -20 °C to 60 °C (-4 °F to 140 °F)</p> <p>Humidity: 90% maximum</p>
I/O Connectors	Power: One AC power socket (3-pin - C14 inlet)

VGA input: One 15-pin D-sub connector (Blue), VGA In, for analog RGB/Component input signals.

VGA output: One 15-pin D-sub connector (Black) for VGA loop through.

Composite Video input: One Yellow RCA jack for CVBS signal.

HDMI input: Two HDMI connectors for supporting HDMI 1.4a. specification HDCP compliant.

Analog Audio input: One 3.5 mm stereo mini phone jack (Blue)/ One x Audio In RCA pair (L/R)

Variable audio output: One 3.5 mm stereo mini phone jack (Green).

Analog Audio input: Two 3.5 mm stereo mini phone jack (Blue) and two pair of RCA connector (Red/White)

Microphone : One 3.5 mm stereo mini phone jack (Pink).

USB (mini USB) port: One mini USB slave for firmware upgrade/ interactive.

5V/1.8A output: One USB type A 5V DC / 1.8 A output for support dongle power.

RS232 port: One 9-pin D-sub for RS232 communication.

RJ-45 port: One RJ-45 connector for build-in for network control.

Touch Unit: one Curtain Module power Jack PHILIPS 260 W user-replaceable lamp

Normal mode: Up to 3000 hours

Eco mode: Up to 5000 hours

Lamp
Lamp life



NOTE: The lamp life rating for any projector is a measure of brightness degradation only, and is not a specification for the time it takes a lamp to fail and cease light output. Lamp life is defined as the time it takes for more than 50 percent of a lamp sample population to have brightness decrease by approximately 50 percent of the rated lumens for the specified lamp. The lamp life rating is not guaranteed

in any way. The actual operating life span of a projector lamp will vary according to operating conditions and usage patterns. Usage of a projector in stressful conditions which may include dusty environments, under high temperatures, many hours per day, and abrupt powering-off will most likely result in a lamp's shortened operating life span or possible lamp failure.

8

Additional Information

For additional information on how to use your projector, please see the **Dell Projectors User Guide** at www.dell.com/support/manuals.

9

Contacting Dell

For customers in the United States, call 800-WWW-DELL (800-999-3355).



NOTE: If you do not have an active Internet connection, you can find contact information on your purchase invoice, packing slip, bill, or Dell product catalog.

Dell provides several online and telephone-based support and service options. Availability varies by country and product, and some services may not be available in your area. To contact Dell for sales, technical support, or customer service issues:

- 1 Visit go to www.dell.com/contactDell.
- 2 Select your region on the interactive map.
- 3 Select a Segment for Contact.
- 4 Select the appropriate service or support link based on your need.

Index

A

Adjusting Projector Focus 10, 31

C

Changing the Lamp 38

Connection Ports

- Audio Input connector 8
- Audio Output connector 8
- Audio RCA connector 8
- Composite Video connector 8
- HDMI 1 connector 8
- HDMI 2 connector 8
- Microphone connector 8
- Mini USB (Mini Type B) 8
- Power cord connector 8
- RJ 45 connector 8
- RS232 connector 8
- Touch Unit power 8
- USB A connector 8
- VGA In connector 8
- VGA Out connector (monitor loop through) 8

Contact Dell 5, 38

D

Dell
contacting 45, 46

I

Interactive Pen
Battery 17
Pen tip 17
Power indicator 17
Power switch 17
Wrist strap holder 17

M

Main Unit 7
Camera 7
Infrared (IR) receivers 7
Lamp cover 7
Lens 7
Power button 7

P

phone numbers 46

R

Remote Control 12

S

Specifications
Aspect Ratio 41
Audio 42
Brightness 41

- Color Wheel Speed 41
- Contrast Ratio 41
- Dimensions 42
- Displayable Color 41
- Environmental 42
- I/O Connectors 42
- Light Valve 41
- Noise Level 42
- Number of Pixels 41
- Power Consumption 42
- Power Supply 41
- Projection Distance 41
- Projection Lens 41
- Projection Screen Size 41
- Projector Weight 42
- Uniformity 41
- Video Compatibility 41

support

- contacting Dell 45, 46

T

- telephone numbers 46